



Istruzioni di montaggio



Installation Instruction



Instruction de montage



Montageanleitung



Instrucciones de montaje



Treeemme
Rubinetteria



Art. RWIT7B_____

TERMOSTATICO INCASSO N° USCITE + LED

N° WAYS CONCEALED THERMOSTATIC + LED

THERMOSTATIQUE À ENCASTRER À N° SORTIES + LED

UP-THERMOSTAT MIT N° WEGE + LED

TERMOSTATICO EMPOTRADO N° SALIDAS + LED



SCAN TO WATCH

Treeemme_tech

QR N° 68



Certified to
NSF/ANSI 61



IT

Grazie per aver scelto Rubinetterie Treemme. Perché il Suo rubinetto funzioni correttamente e possa durare nel tempo, occorre che vengano rispettate le procedure di installazione ed manutenzione illustrate in questo opuscolo.

EN

Thank you for choosing Rubinetterie Treemme. In order to ensure that your tap works properly and it lasts over time, you must carefully observe our installation instruction and care and maintenance procedures described on this brochure.

FR

Nous vous remercions d'avoir choisi Rubinetterie Treemme. Pour que votre robinet fonctionne d'une manière correcte et puisse durer longtemps, il est convenable de respecter les modalités et d'installation et d'entretien indiqués dans cette notice.

DE

Vielen Dank, dass Sie sich für Rubinetterie Treemme entschieden haben. Weil Ihr Wasserhahn funktioniert Wenn Sie die in dieser Broschüre beschriebenen Installations- und Wartungsvorgänge einhalten, müssen sie beachtet werden.

SP

Gracias por elegir Rubinetterie Treemme. Para que su grifo funcione correctamente y para que sea duradero, es necesario el respeto de los procedimientos de instalación y de mantenimiento que se describen en este folleto.



FR

On recommande de purger les tubes d'alimentation avant de placer le produit

IT

Si raccomanda prima di installare il prodotto di spurgare accuratamente i tubi di alimentazione

DE

Es ist empfohlen bevor den Artikel zu installieren die Zuleitungsrohre zu spülen

EN

It is suggested to purge the inlet tubes before to install the product

SP

Enjaguar con mucha atención los tubos de alimentación antes de conectar el producto

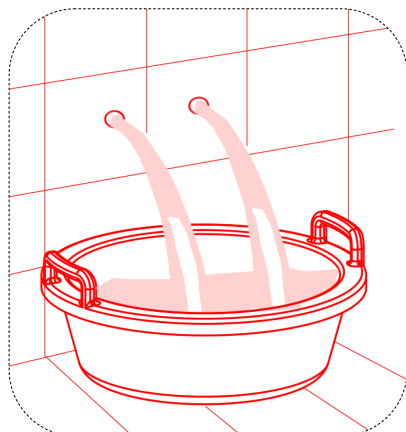

- PARTI INCASSO / CONCEALED PARTS P_4
- TEST IMPIANTO / SYSTEM TEST P_11
- PARTI ESTERNE / EXTERNAL PARTS P_13
- RESET CARTUCCIA TERMOSTATICA / THERMOSTATIC CARTRIDGE RESET P_16
- FUNZIONAMENTO / OPERATION P_18

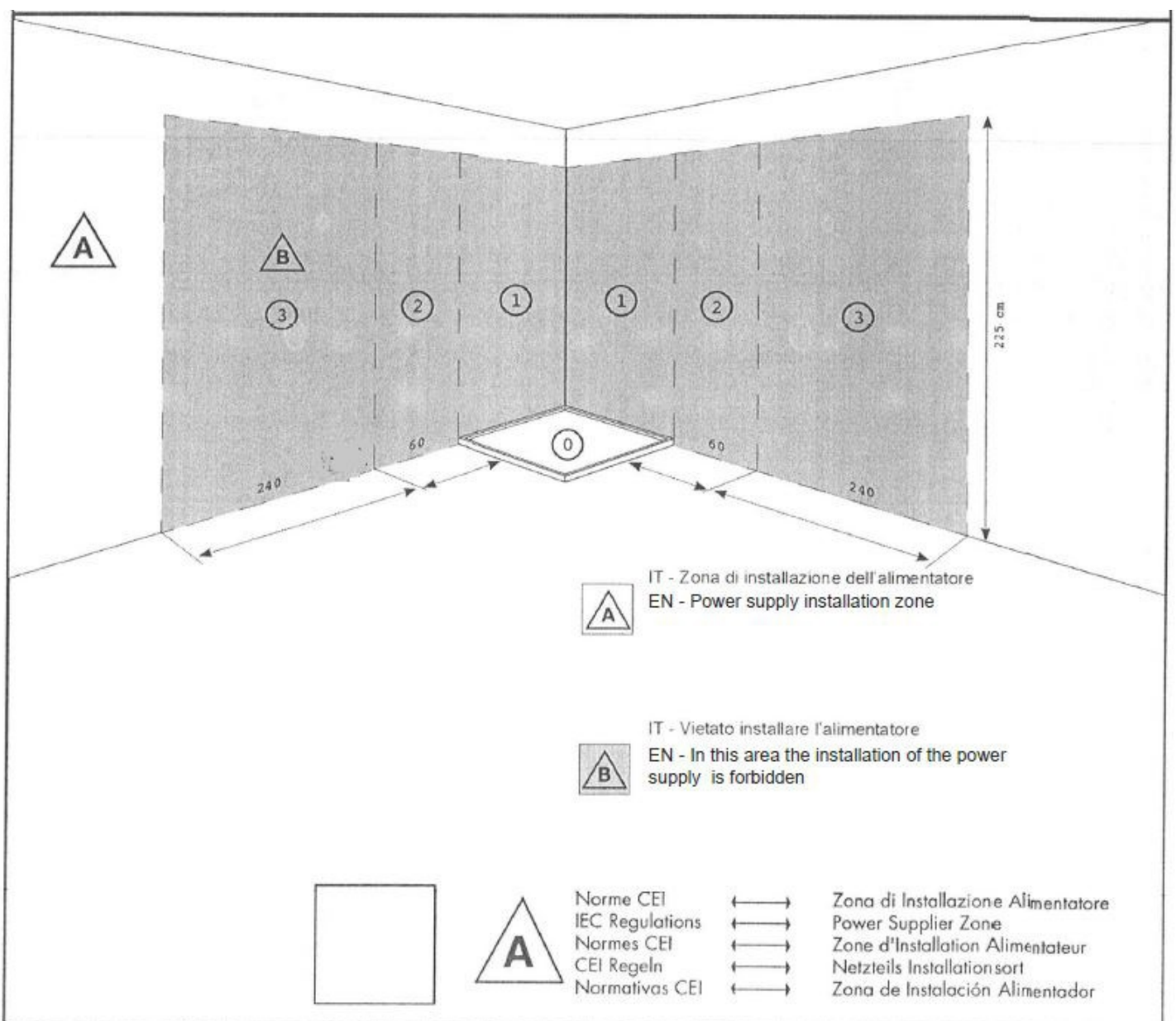

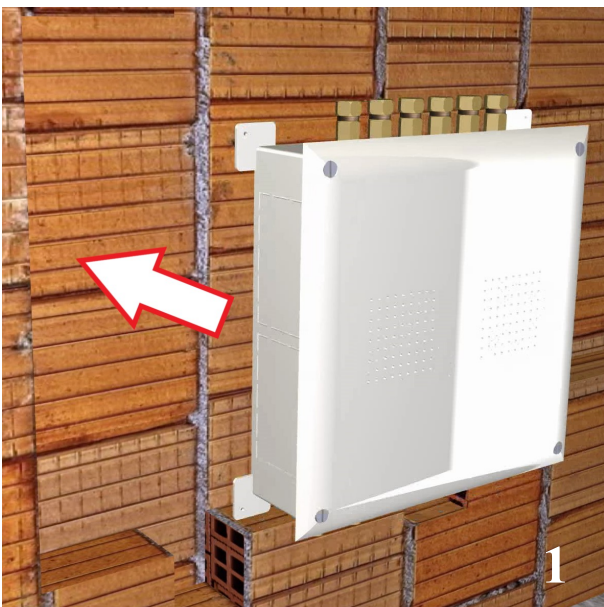
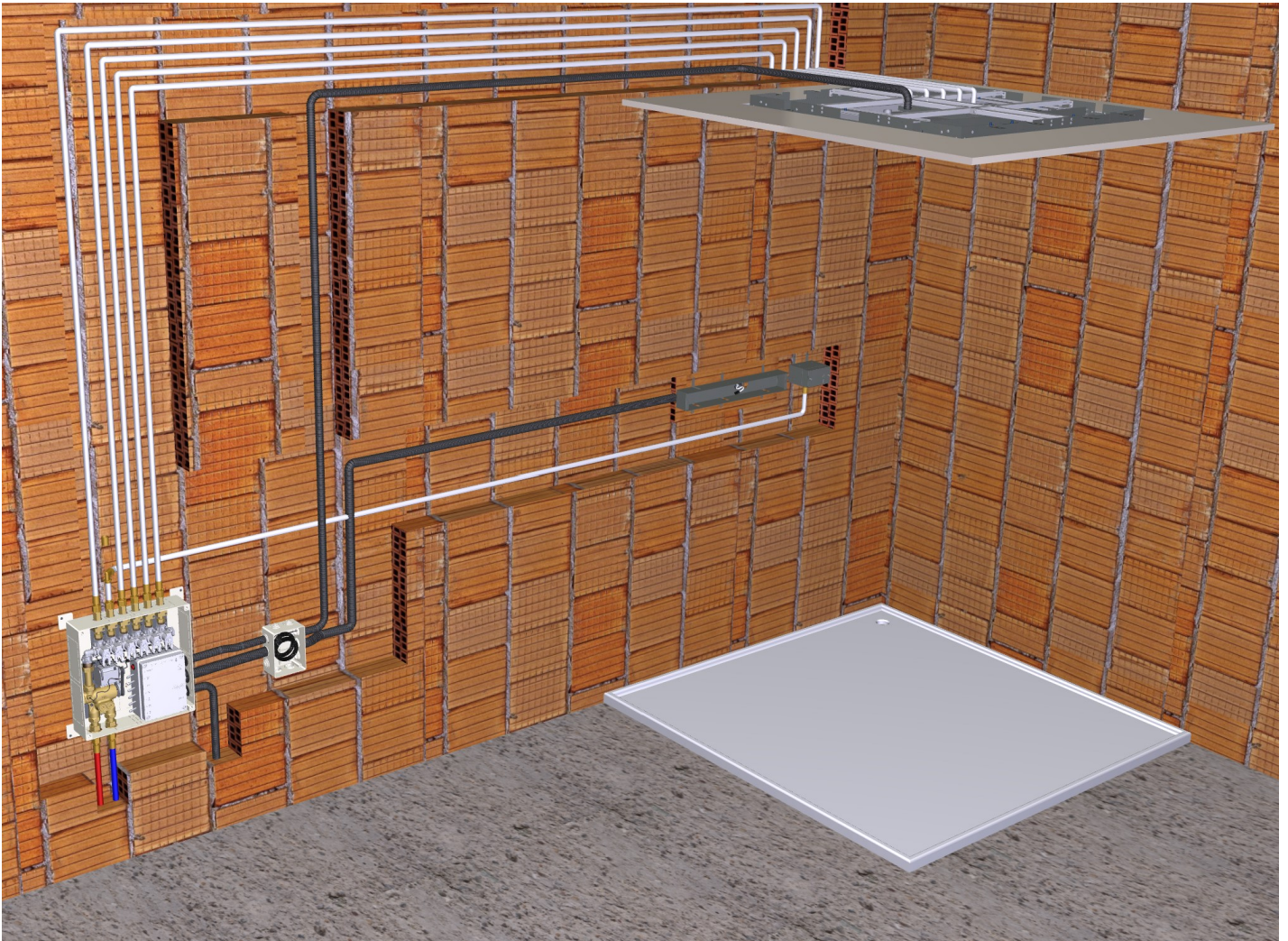

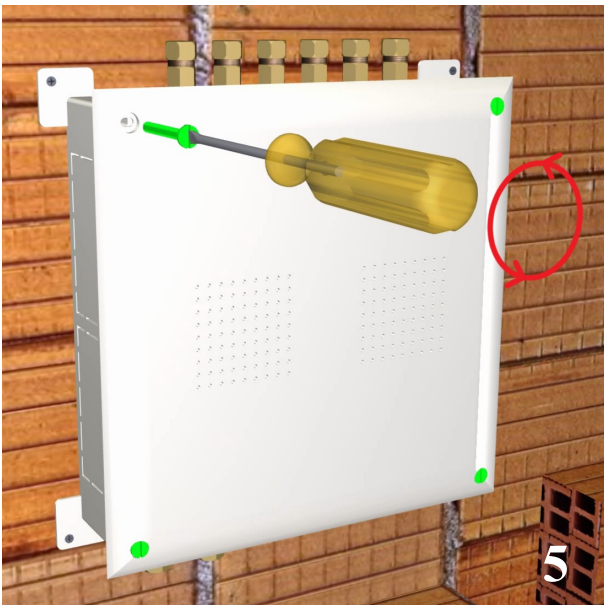
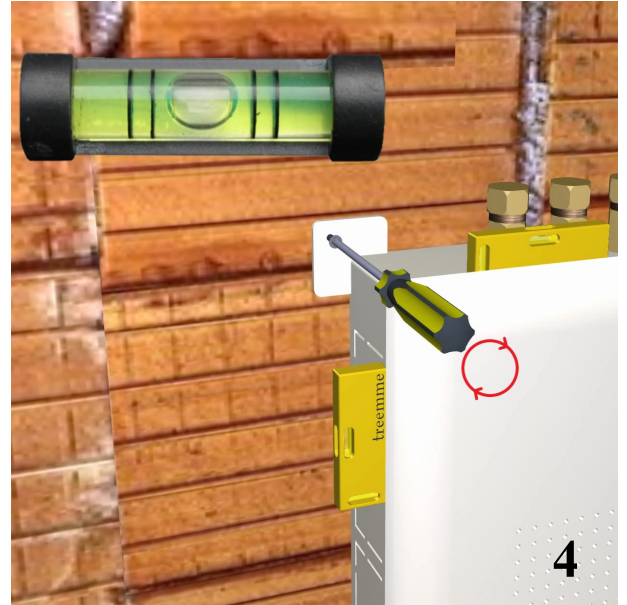

ORDINE DI PRODUZIONE + TEST TEMPERATURE
PRODUCTION ORDER + TEMPERATURE TEST

↓

	th ro	th ro	th ro	th ro	th ro	th ro
SR	25	27	29	31	33	35
FR	40	42	44	46	48	50
FC	15	17	19	21	23	25

6

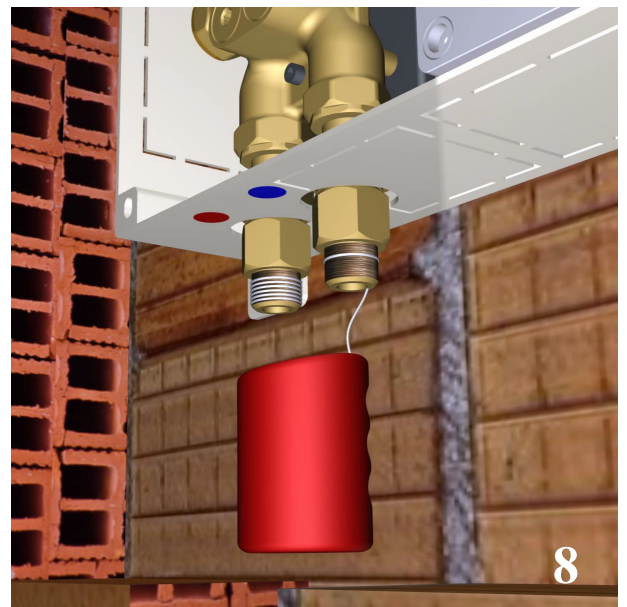
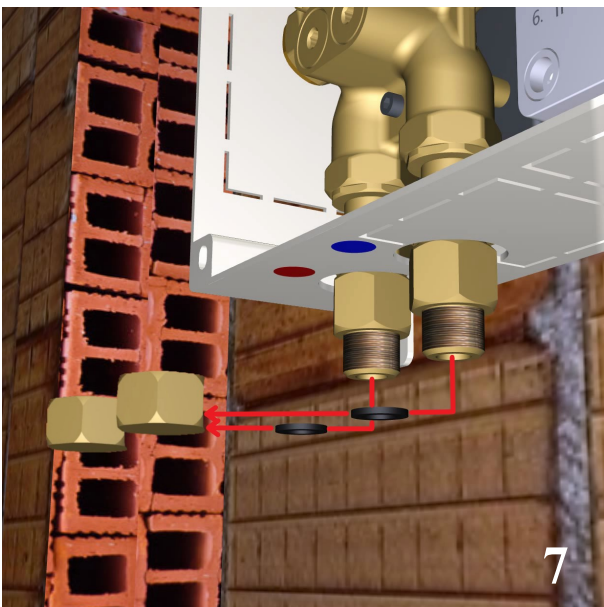

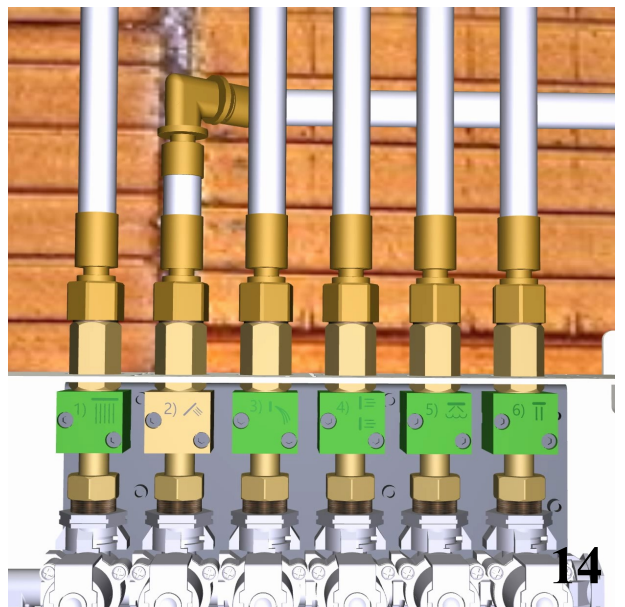
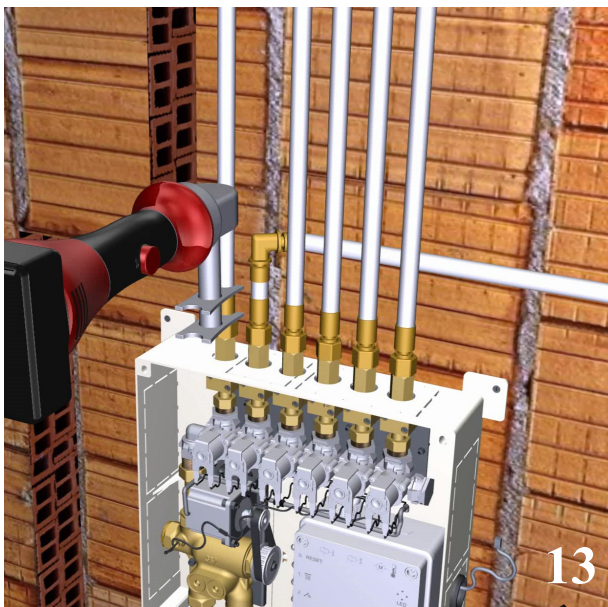
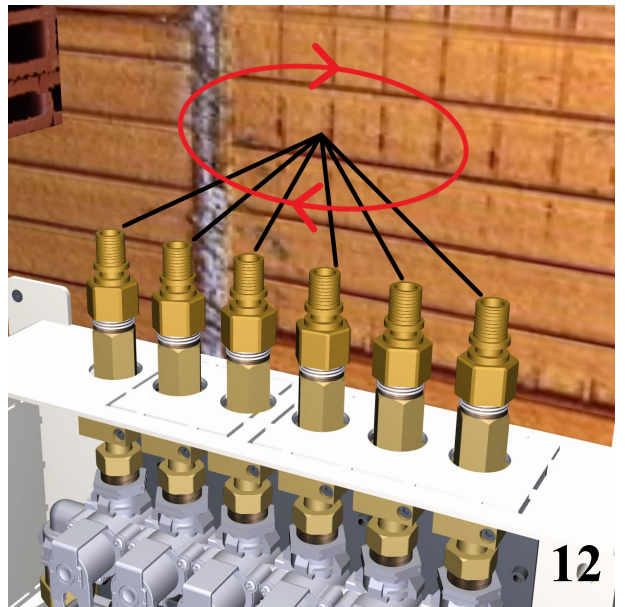
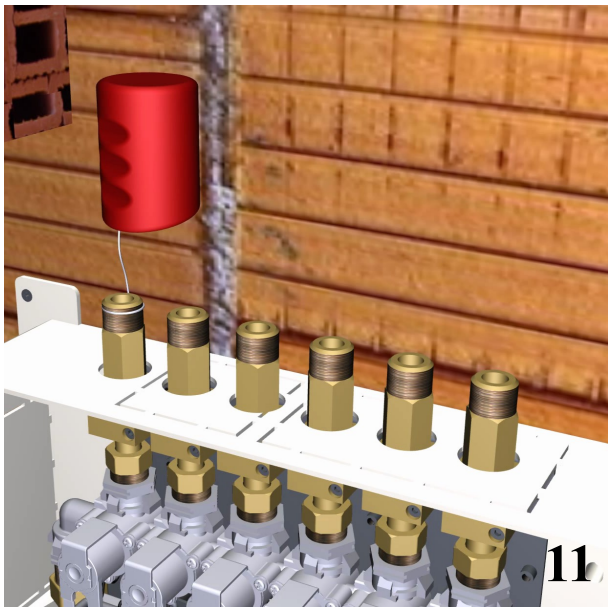
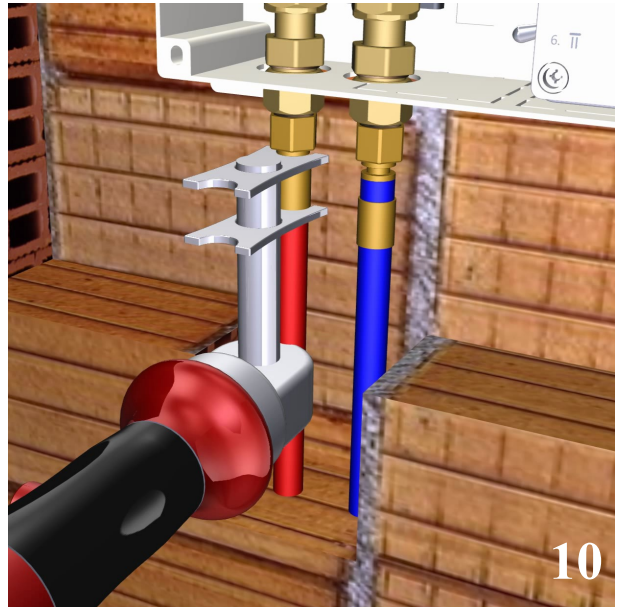
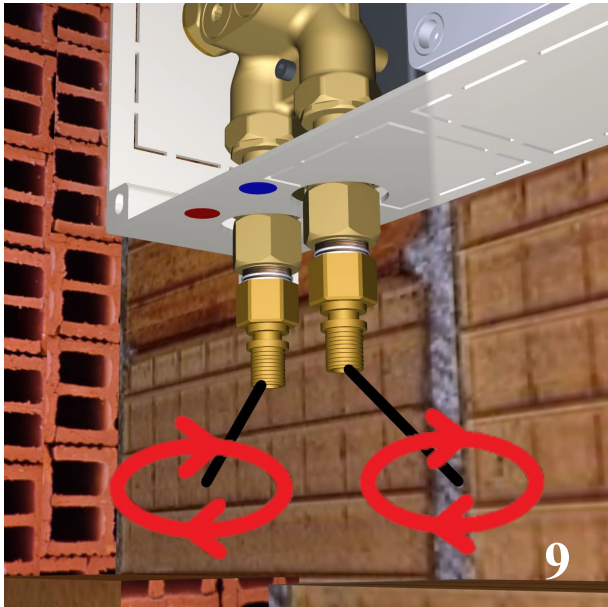

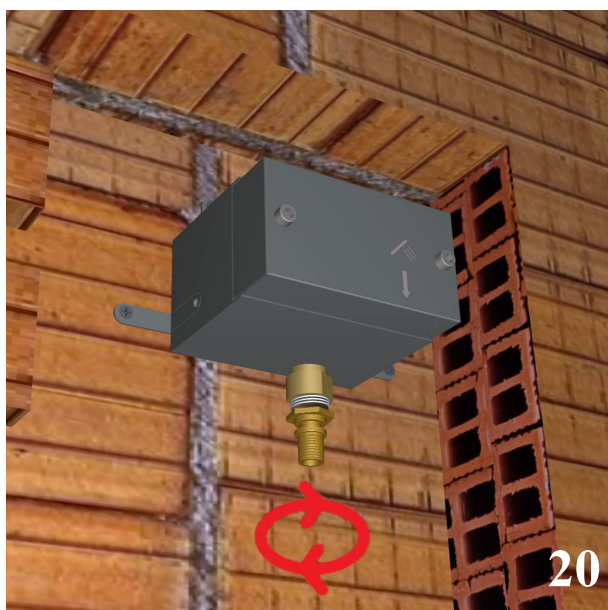
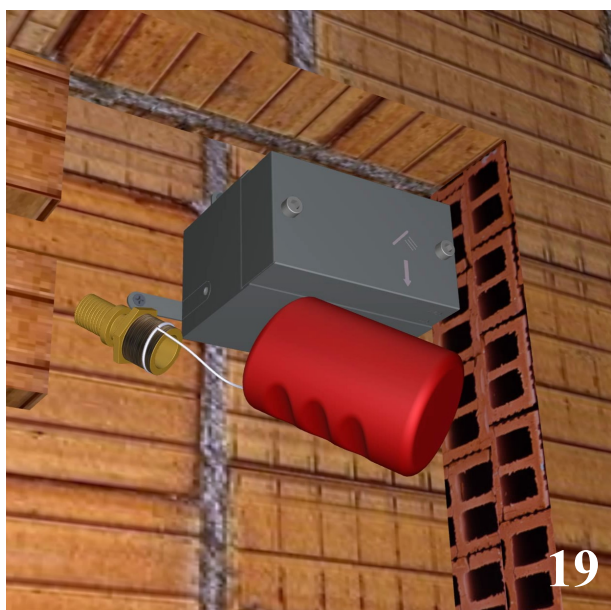
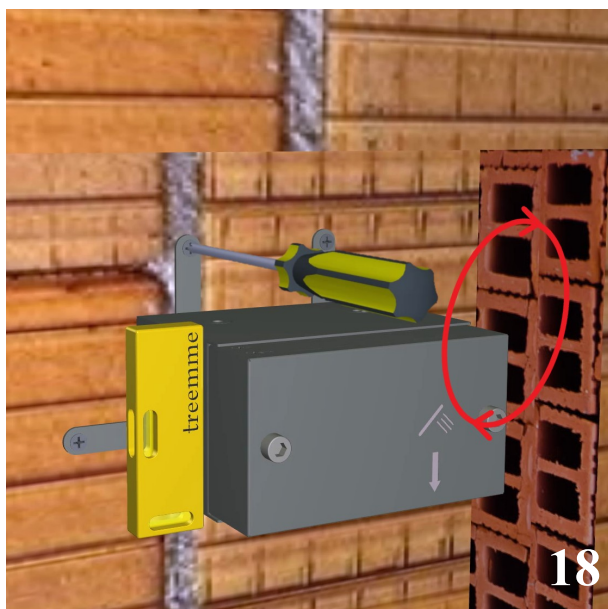
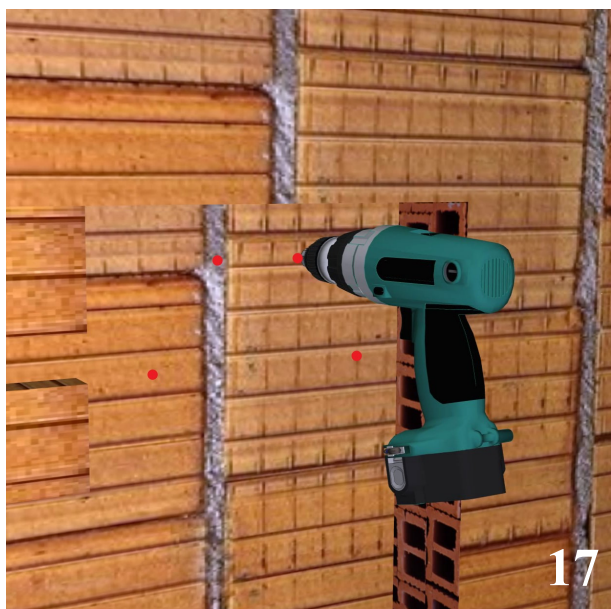
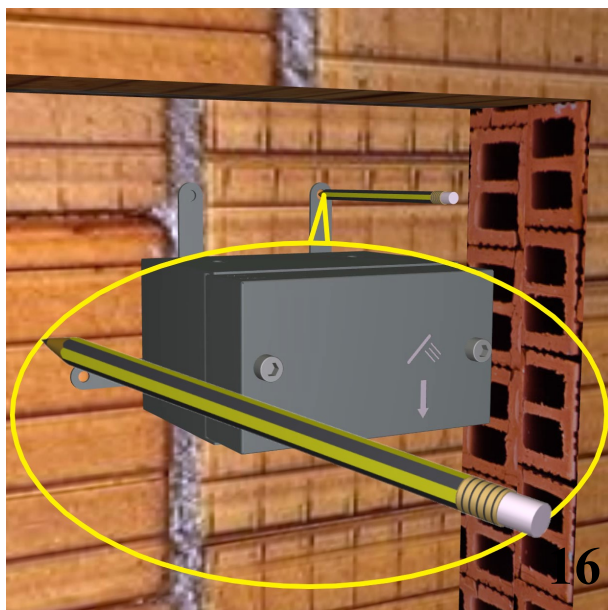
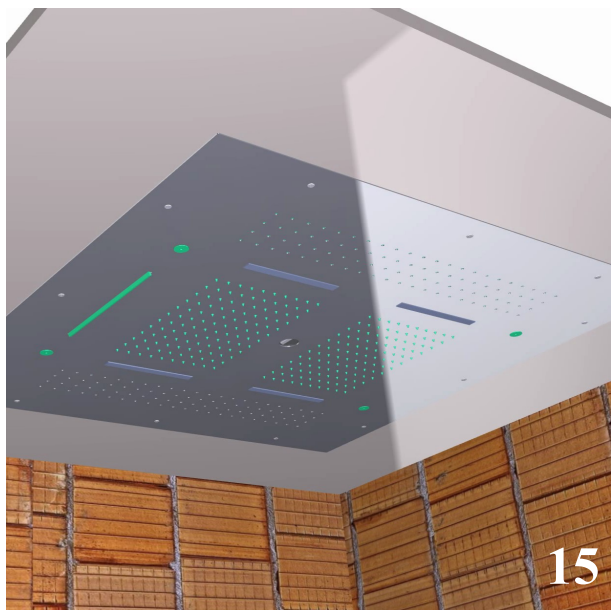

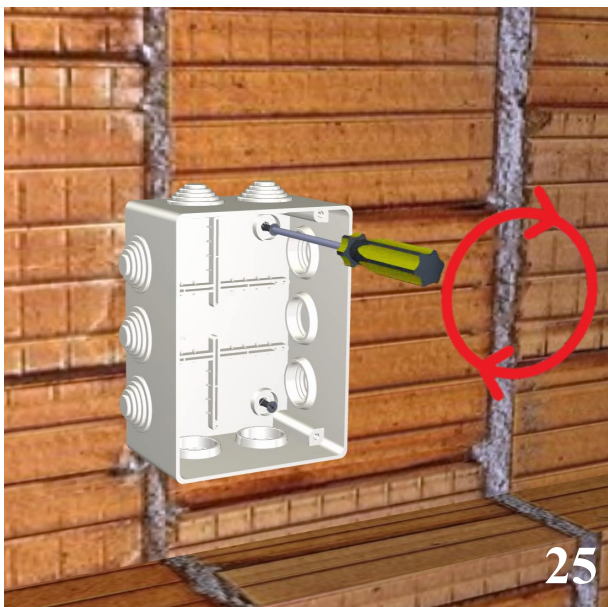
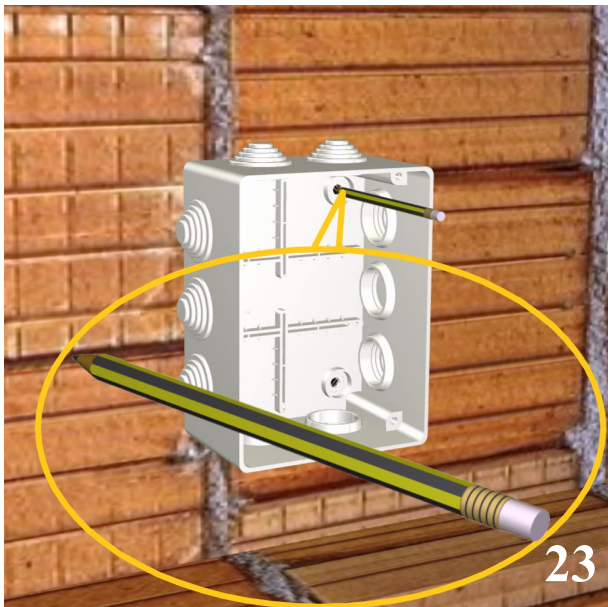
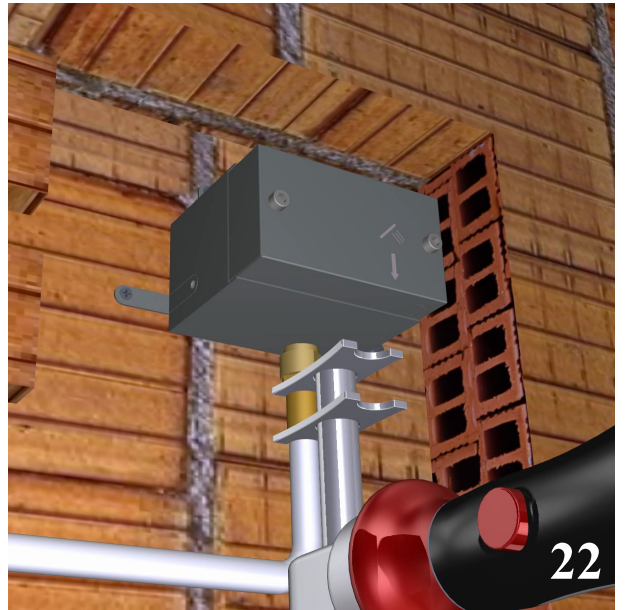
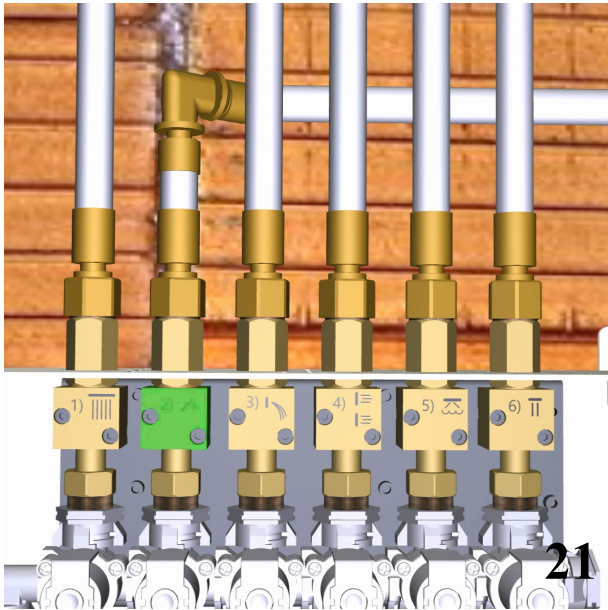

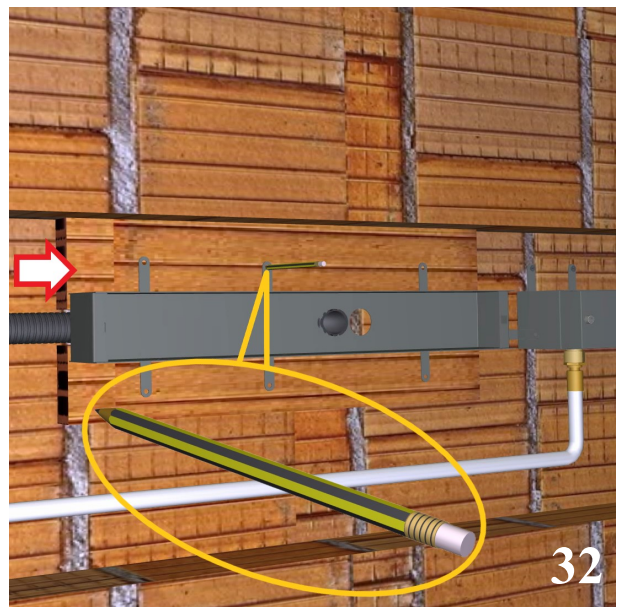
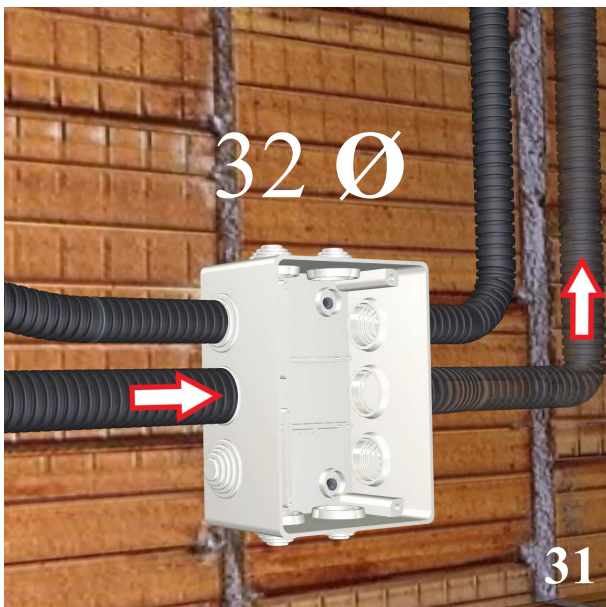
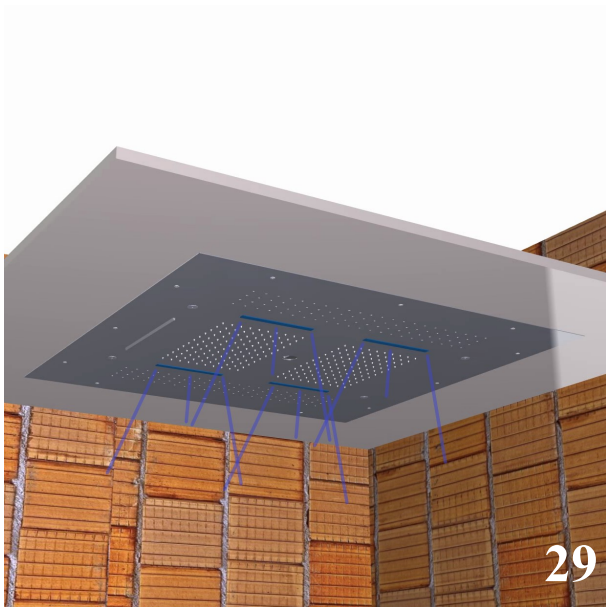
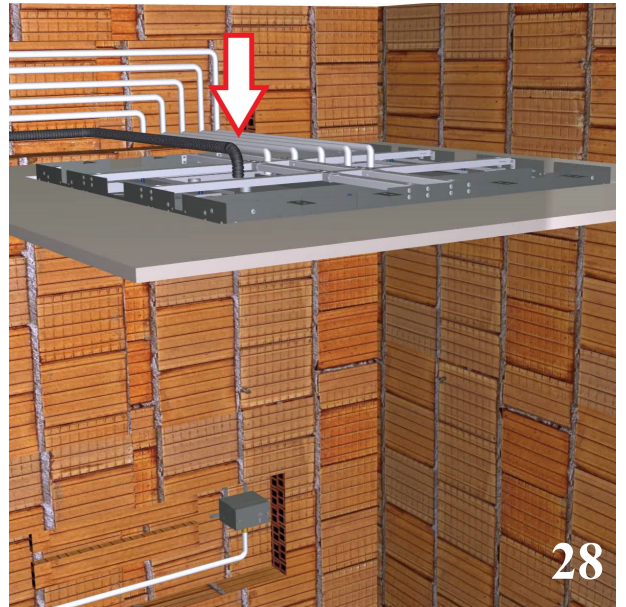
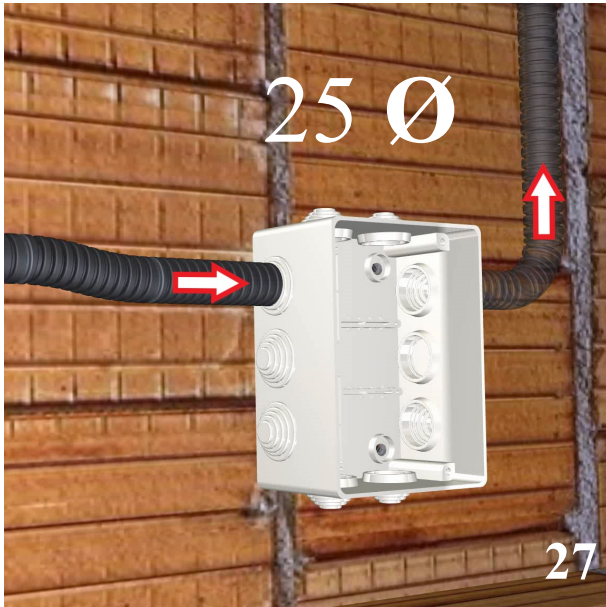

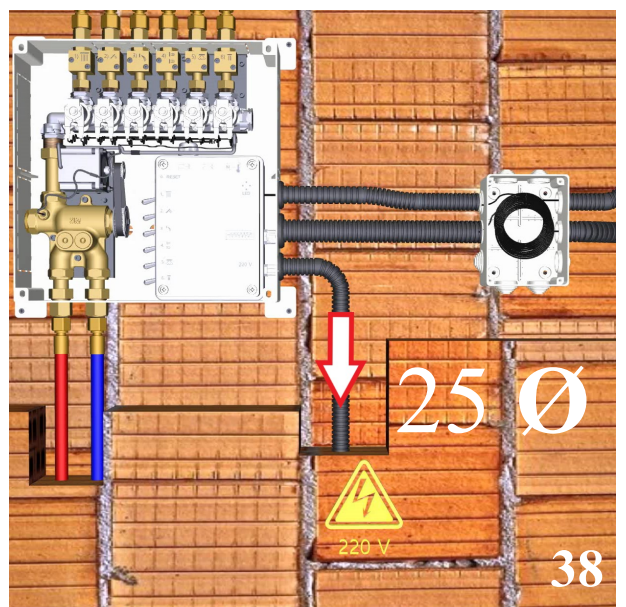
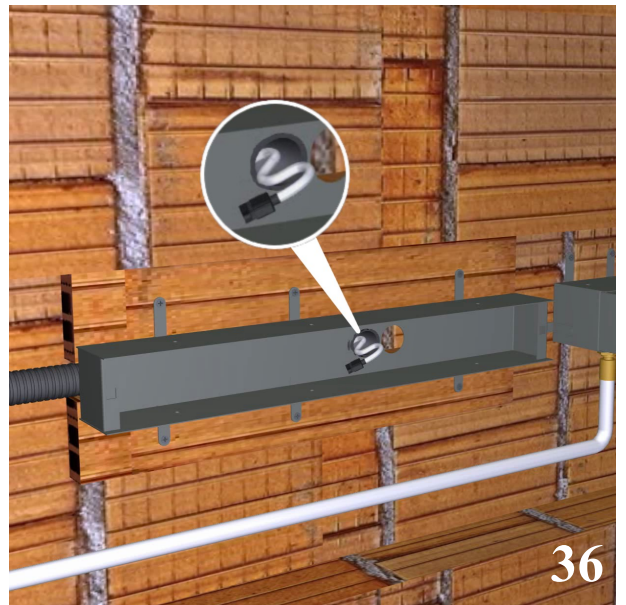
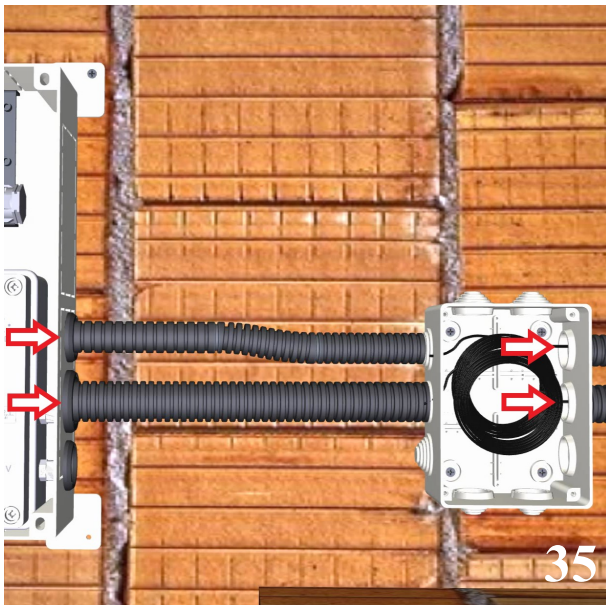
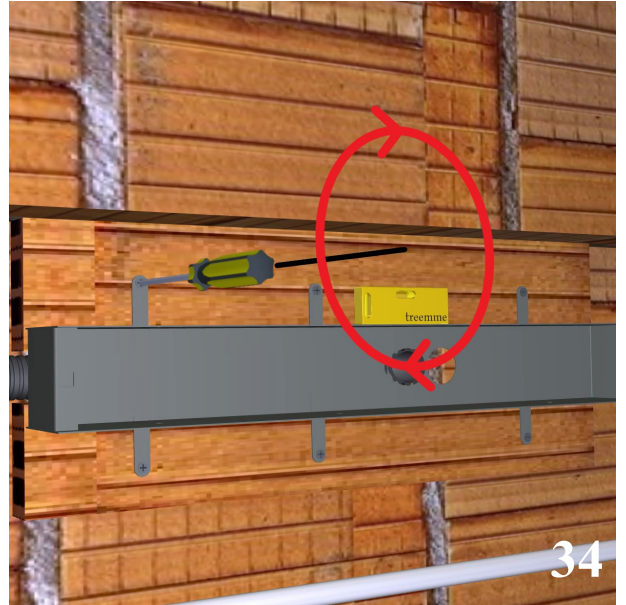
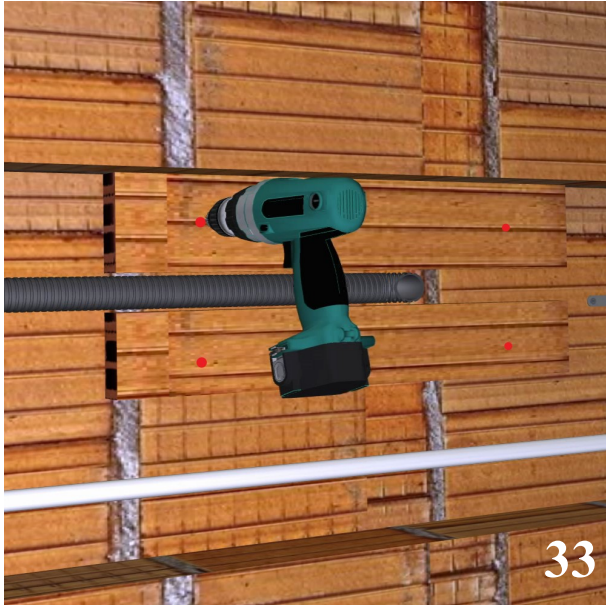

ITALIANO

- Per effettuare il test è necessario che l'impianto sia spento e alimentato.
- Tappare le uscite, azionare una leva alla volta per attivare l'uscita indicata dalle icone poste a fianco di esse e quindi individuare eventuali perdite

ENGLISH

- To carry out the test, the system must be switched off and powered
- Plug the outlets, operate one lever at a time to activate the output indicated by the icons placed next to them and then identify any losses

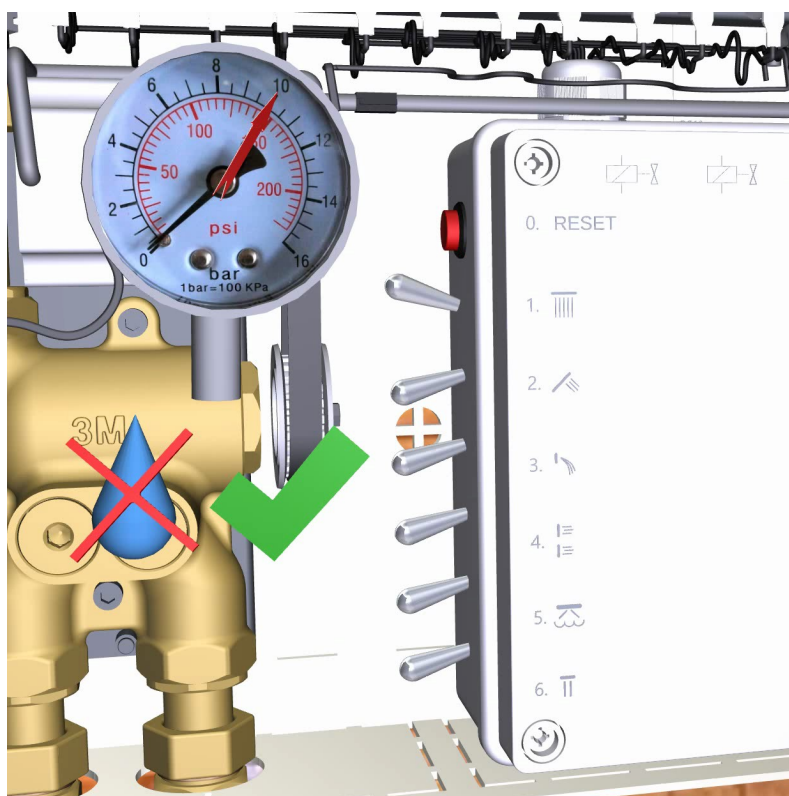

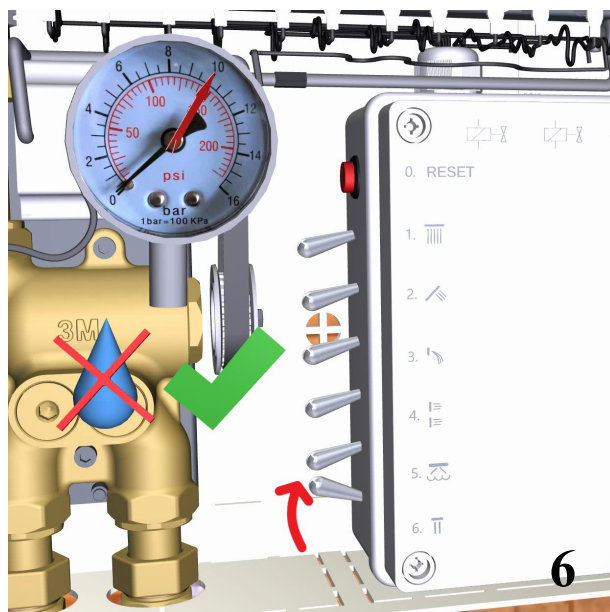
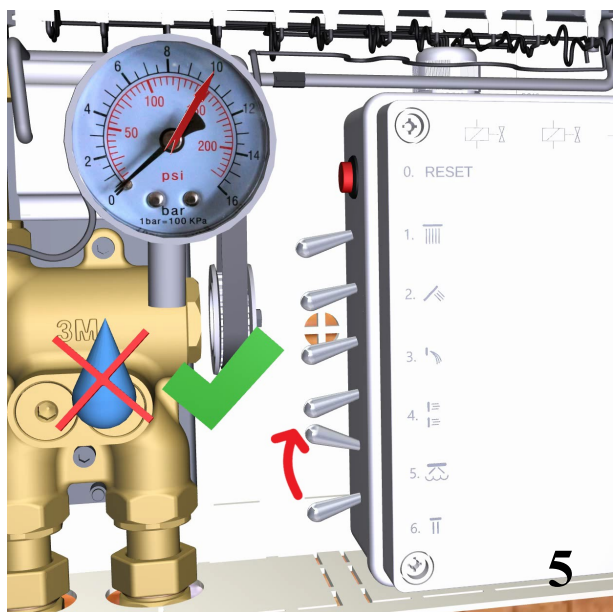
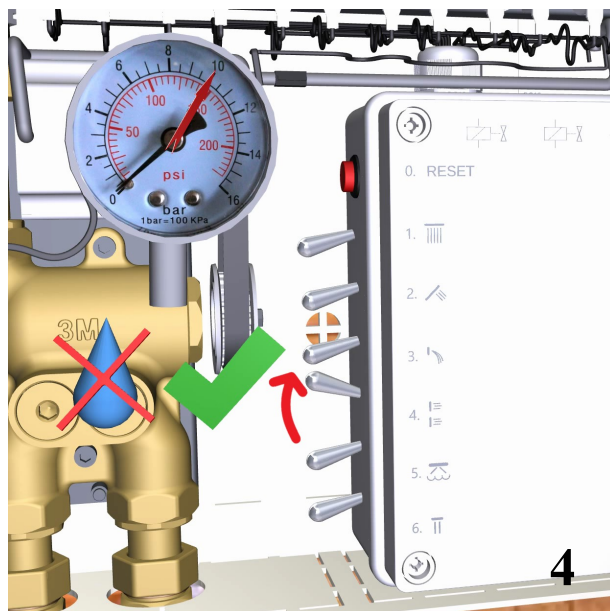
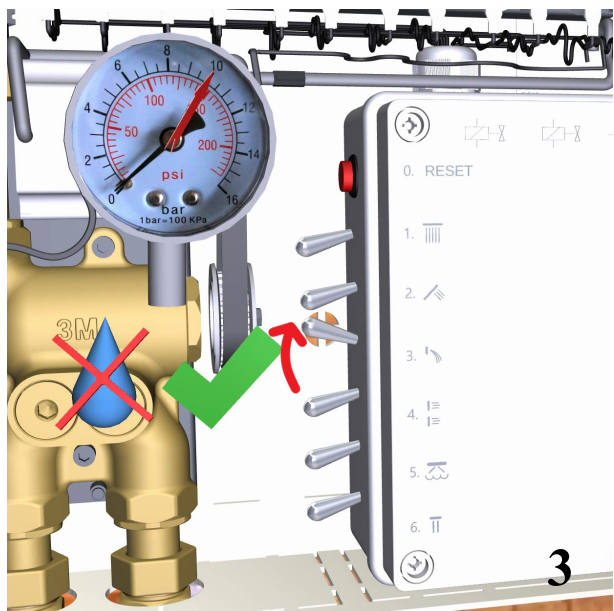
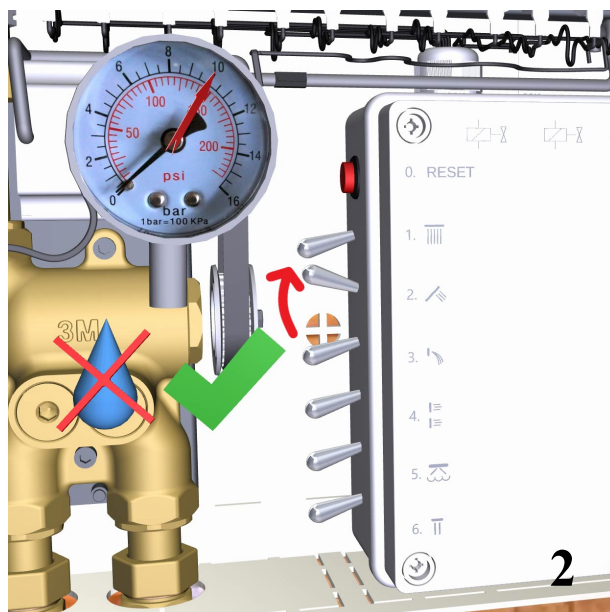
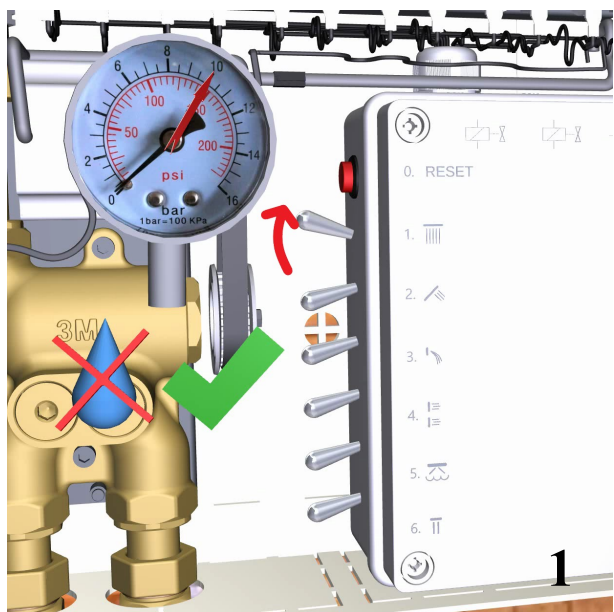

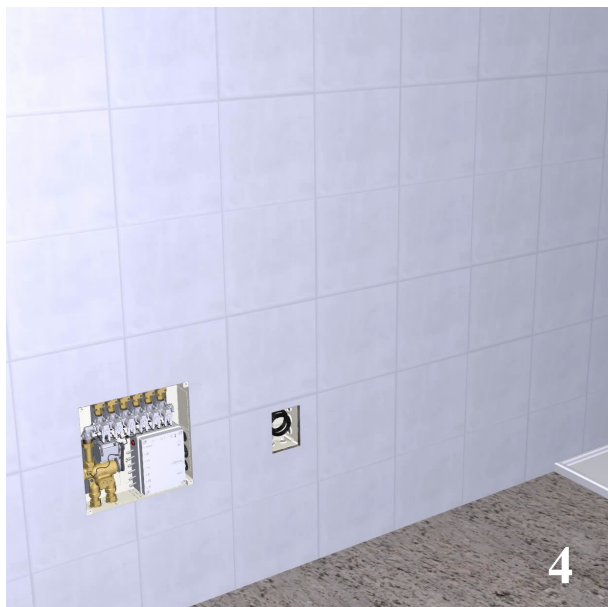
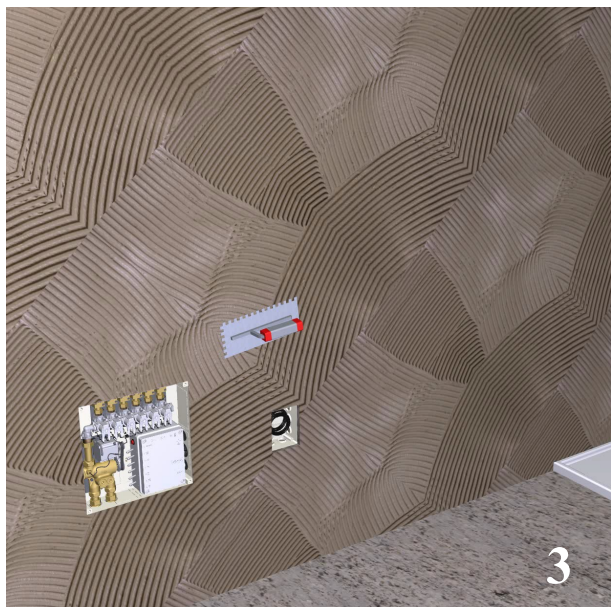

ORDINE DI PRODUZIONE + TEST TEMPERATURE
PRODUCTION ORDER + TEMPERATURE TEST

treeemme
instruments for water

	TH 15	TH 20	TH 25	TH 30	TH 35	TH 40	TH 45
OSP 20x3-E-compact	31	45	60	80	100	120	150
F RM	30	35	35	35	35	35	35
T G60	15	20	20	20	20	20	20

6

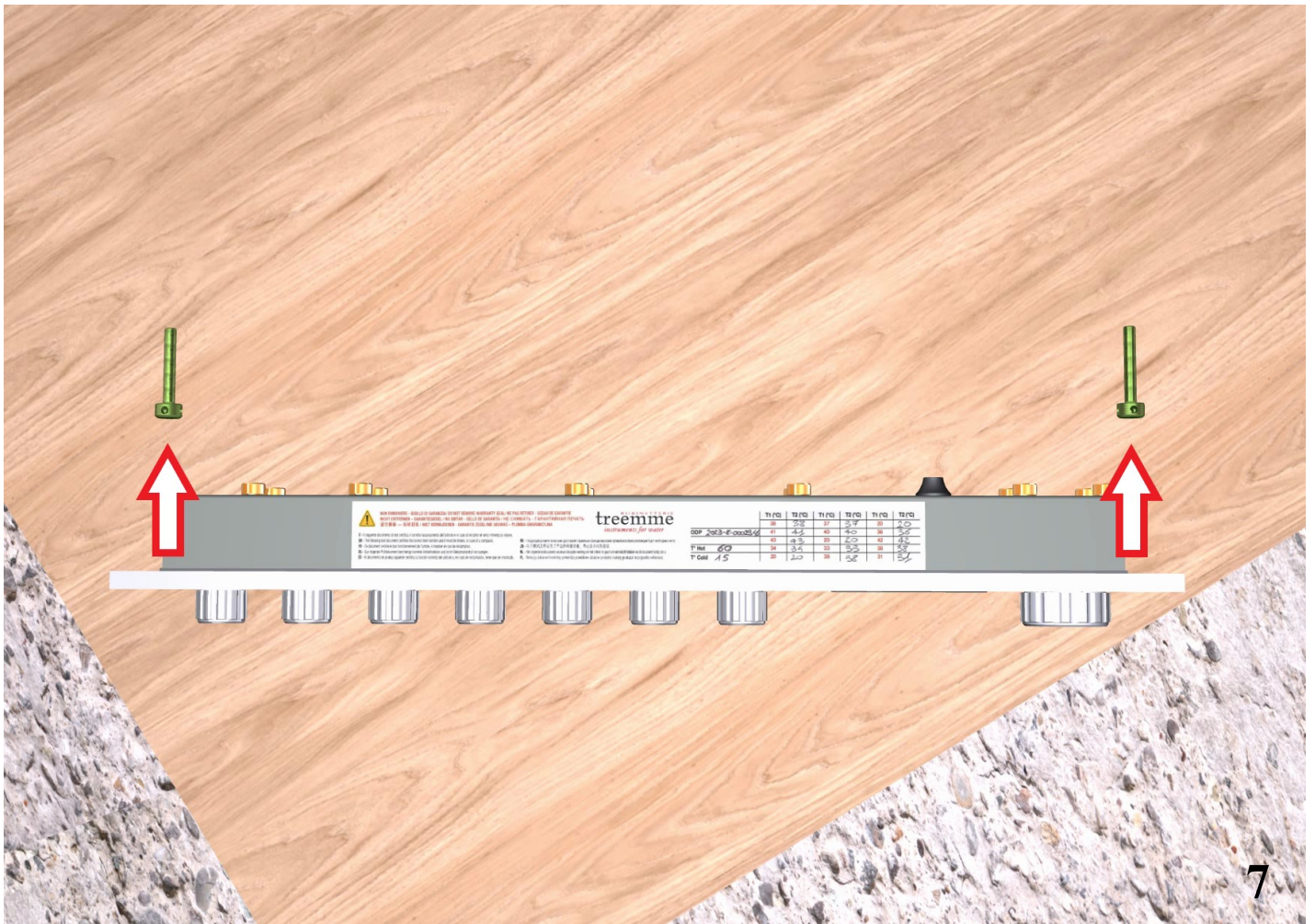

7

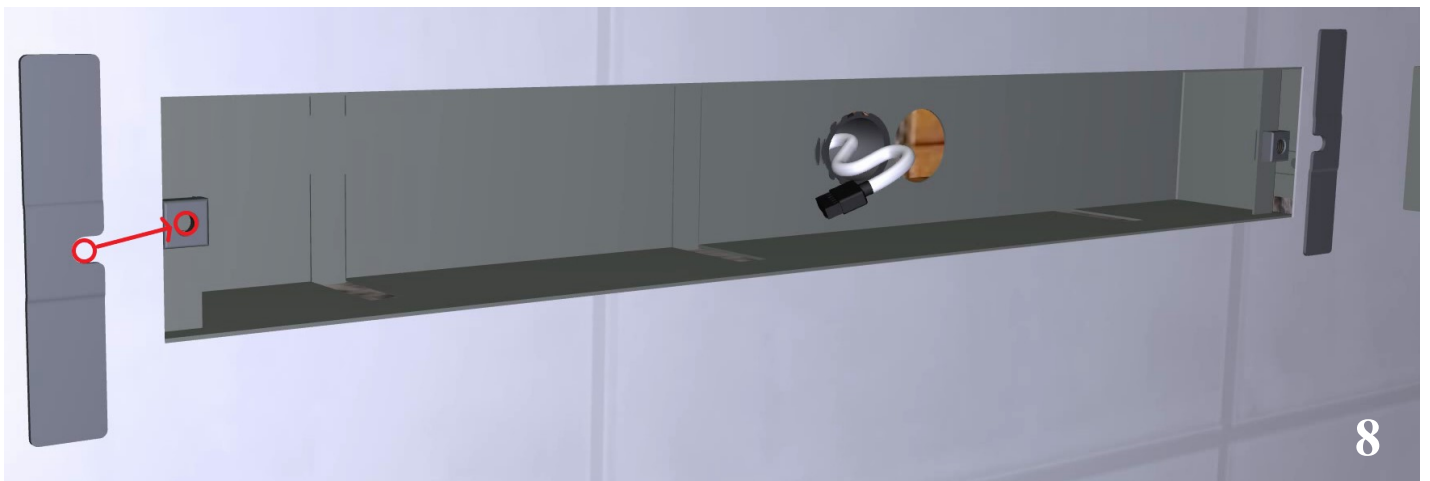

8

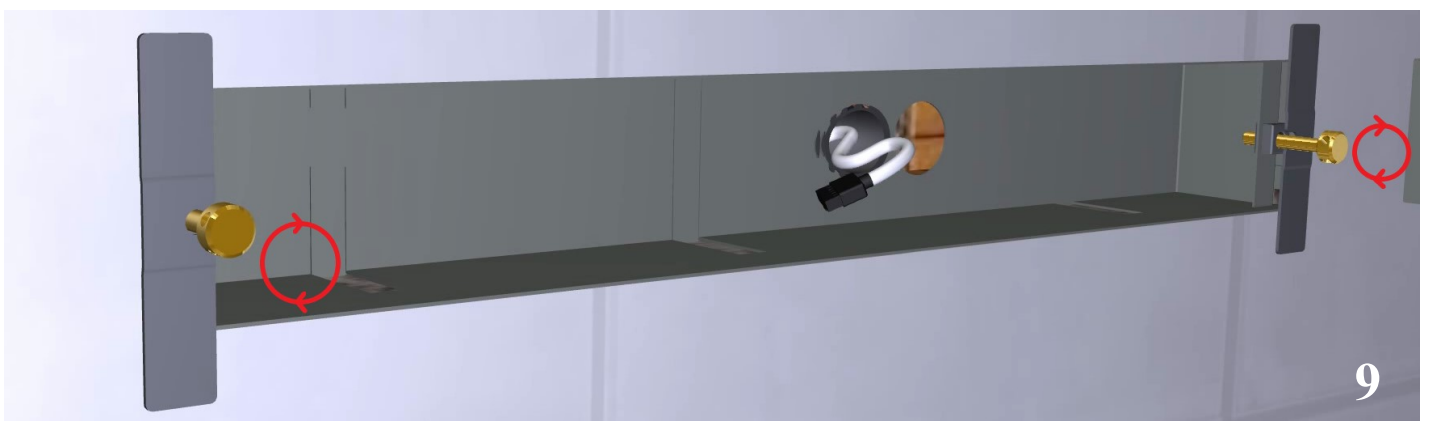

9

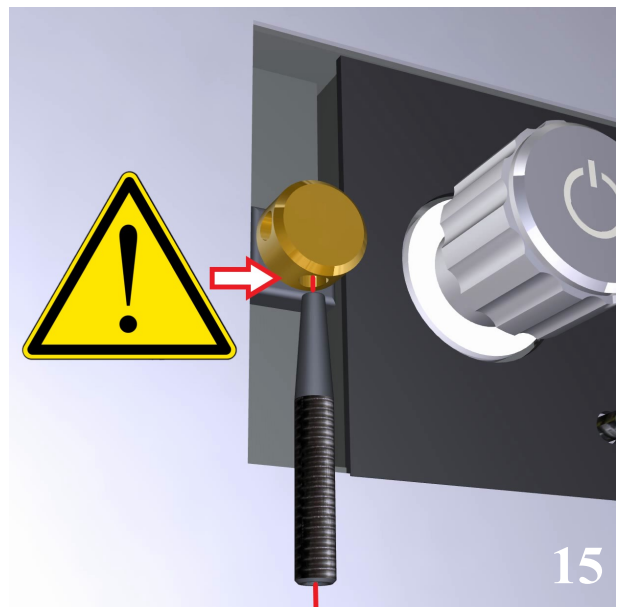
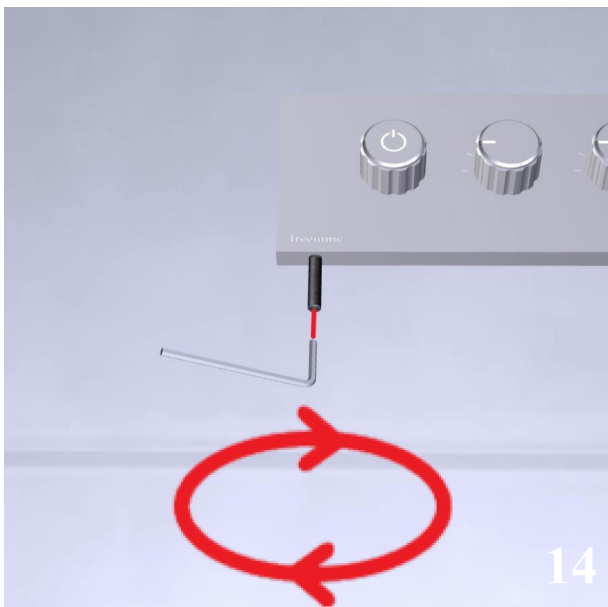
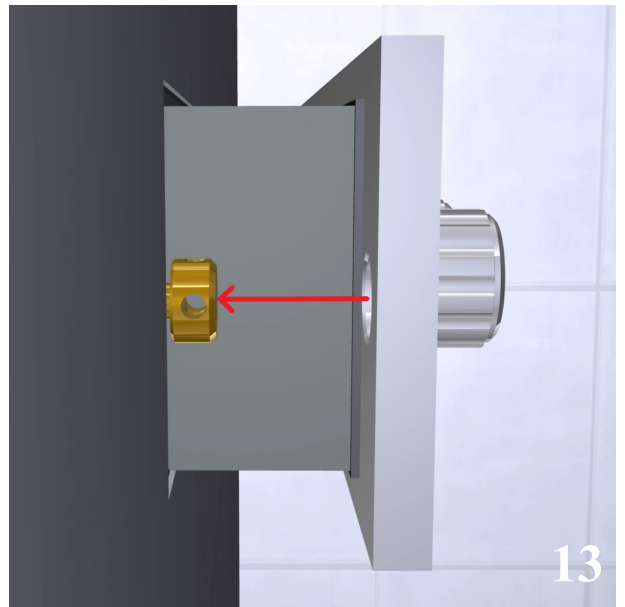
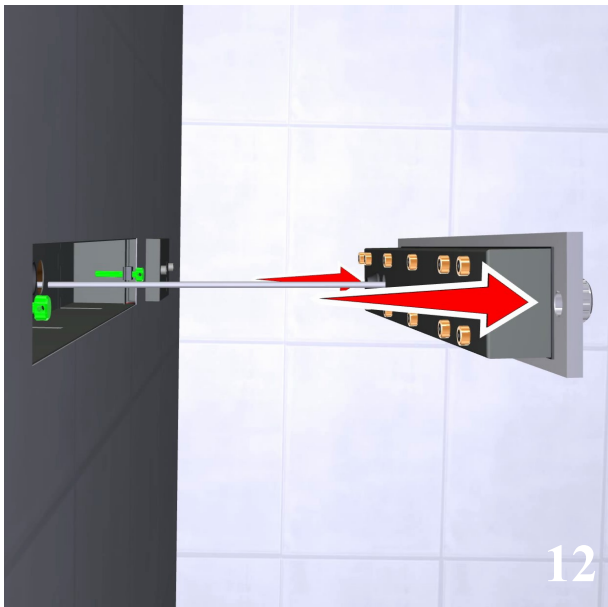
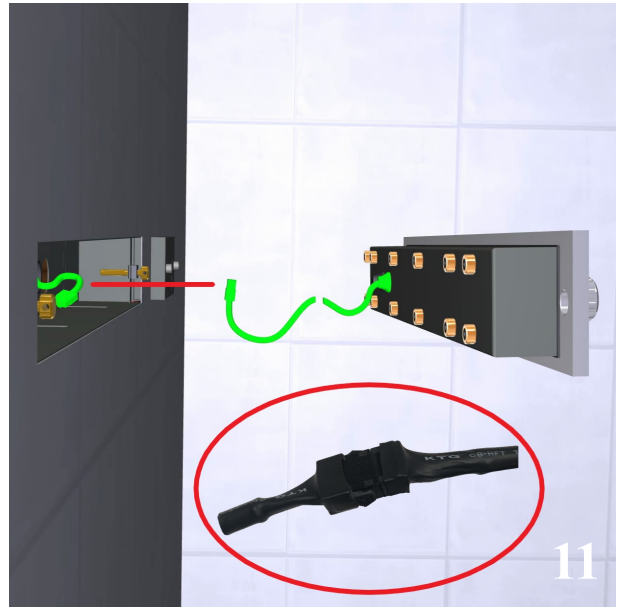
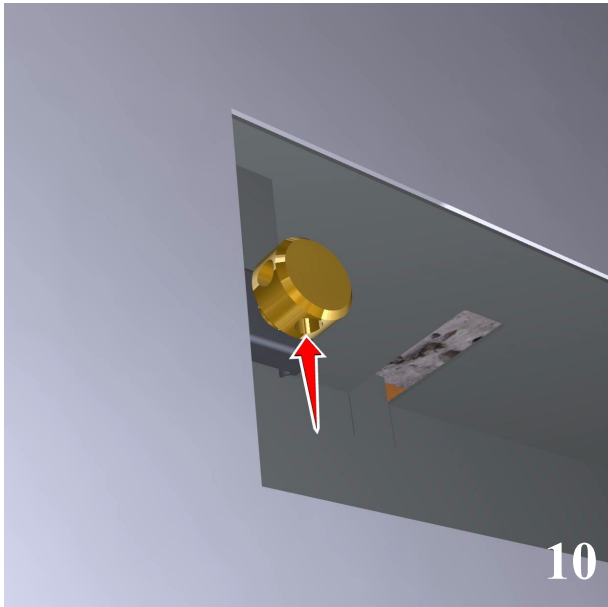

ITALIANO

Per effettuare il reset della cartuccia termostatica è necessario:

- ▶ Premere per pochi secondi il tasto luminoso rosso
- ▶ Quando lo schermo lampeggia, ruotare la maniglia della temperatura fino a raggiungere i 38°C.
- ▶ Attendere che l'acqua arrivi a una temperatura compresa tra 34°C e 42°C
- ▶ Attendere che il motore regoli la cartuccia e si stabilizzi
- ▶ Se il reset è andato a buon fine, il display si spengerà e sarà possibile usufruire delle normali funzioni dell'articolo.

ENGLISH

To reset the thermostatic cartridge it's necessary:

- ▶ Press the red luminous button for few seconds
- ▶ When the screen flashes, turn the handle of the temperature until it reaches 38°C
- ▶ Wait for the water to reach a temperature between 34°C and 42°C
- ▶ Wait for the motor to adjust the cartridge and stabilize
- ▶ If the reset is successful, the display will turn off and it will be possible to use the normal functions of the article

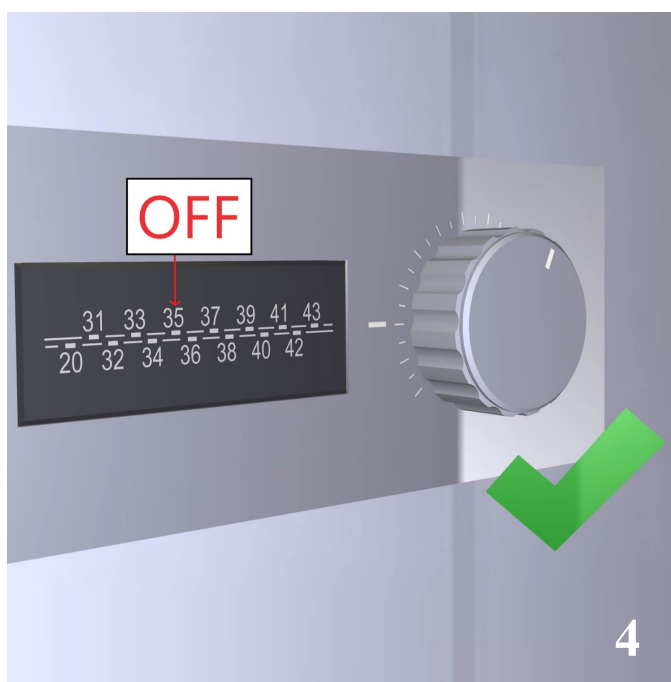
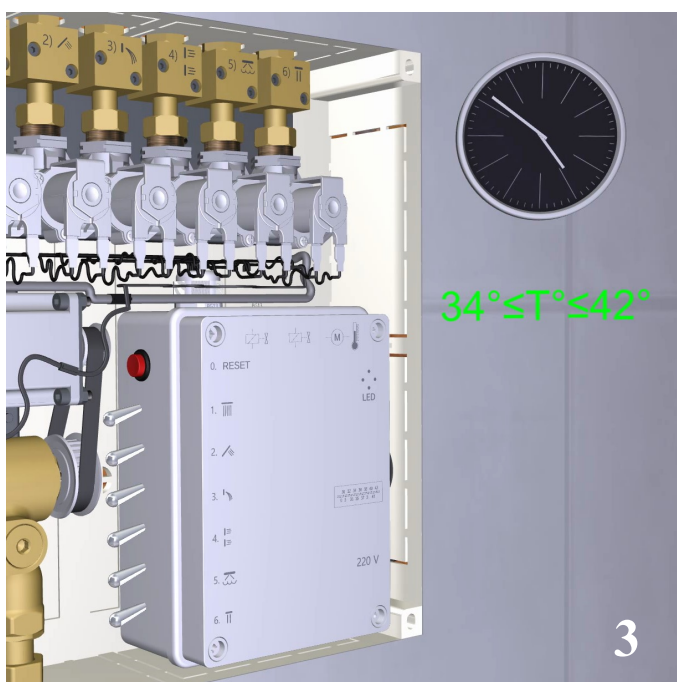
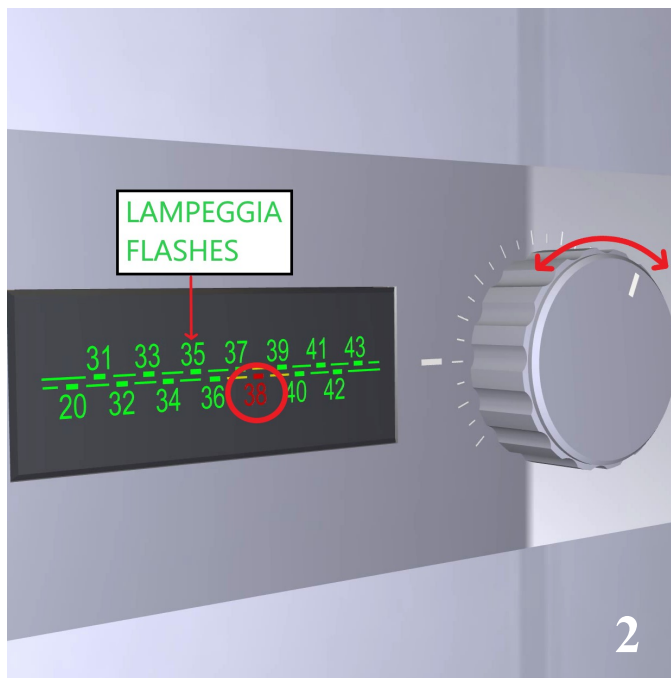
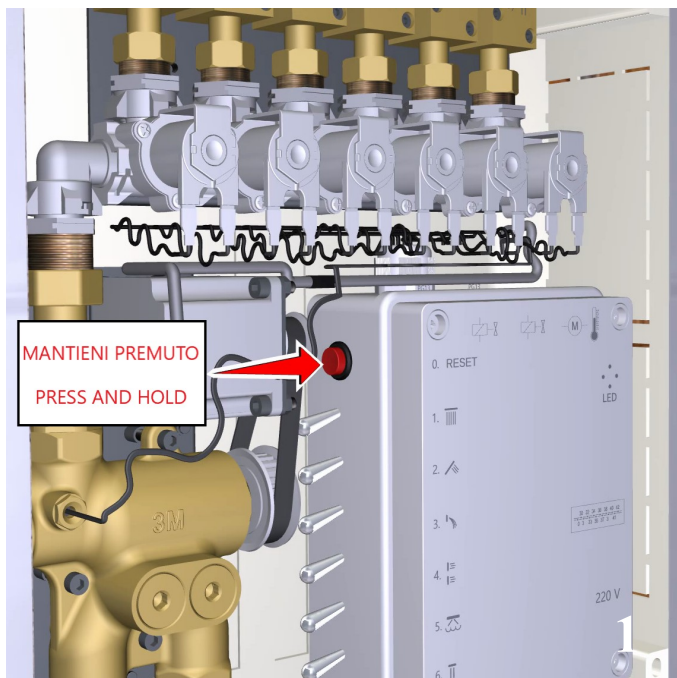

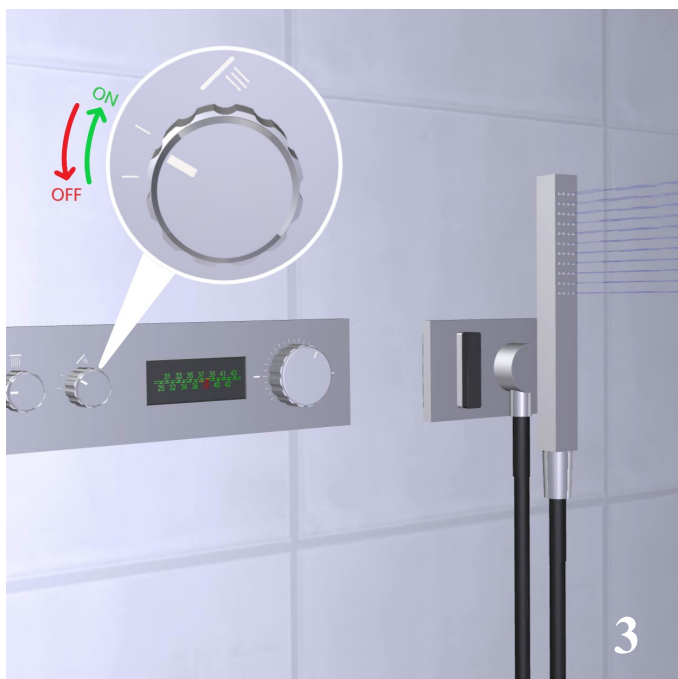
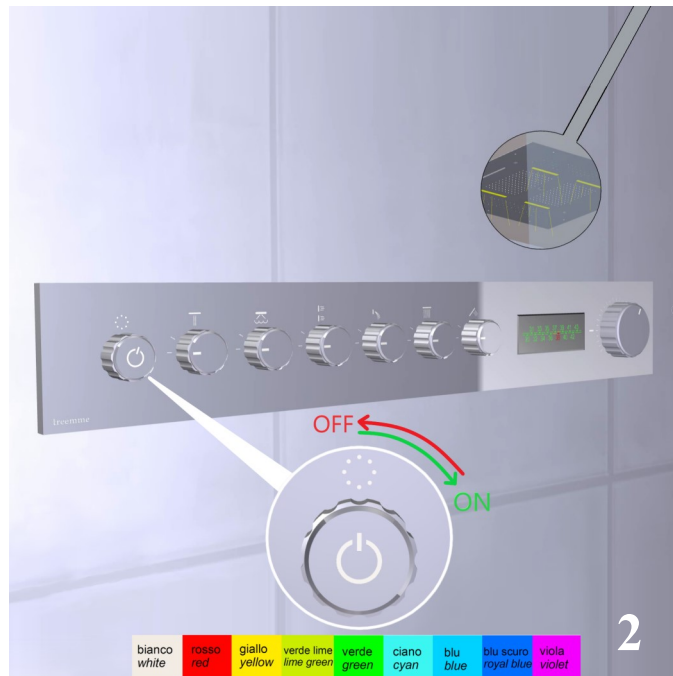



RUBINETTERIE
treemme
instruments for water